

CE



User's Guide



<http://www.omega.com>
e-mail: info@omega.com



PCL-130 Process Calibrator

CONTENTS

GENERAL OPERATING INSTRUCTIONS	3
TURN ON	5
CONNECTIONS	5
FIELD & BENCH USE (TILT STAND).....	6
CHANGING BATTERIES.....	6
CONFIGURING TEMPERATURE SCALES	7
ENABLING AUTO-OFF.....	7
RESTORING DEFAULT SETTINGS.....	7
DISPLAY CONTRAST & BACKLIGHTING.....	8
SELECTING FUNCTIONS & RANGES.....	9
SOURCE MODE OPERATING INSTRUCTIONS	10
STORING & RECALLING QUIK-CHEK® OUTPUTS	10
SOURCE MODE CONNECTION INSTRUCTIONS	
CALIBRATE MILLIAMPS INPUTS	11
SIMULATE 2-WIRE TRANSMITTERS.....	12
CALIBRATE VOLTAGE INPUTS	13
CHECK 1-5 VOLT INPUTS WITHOUT	
DISCONNECTING WIRES	14
CALIBRATE THERMOCOUPLE INPUTS.....	16
CALIBRATE RESISTANCE INPUTS	17
CALIBRATE RTD INPUTS.....	18
CALIBRATE FREQUENCY INPUTS	20
READ MODE OPERATING INSTRUCTIONS	21
MIN/MAX	21
OUT OF RANGE SIGNALS.....	21
READ MODE CONNECTION INSTRUCTIONS	
READ MILLIAMPS OUTPUTS.....	22
READ VOLTAGE OUTPUTS.....	23
READ AC VOLTAGES.....	24
MEASURE THERMOCOUPLE SENSORS	25
READ RESISTANCE	26
CHECK CONTINUITY	27
MEASURE RTD SENSORS.....	28
COUNT FREQUENCIES.....	30
CALIBRATE 2 & 4 WIRE TRANSMITTERS	32
PRESSURE (WITH COMPANION PRESSURE MODULES)	
READ PRESSURE	34
CALIBRATE PRESSURE TRANSMITTERS.....	36
SPECIFICATIONS	40
WARRANTY	48

GENERAL INFORMATION

Your New PCL-130

Lighten your load...take the PCL-130 to every site. It's like bringing a cartload of test equipment from the shop to the control room or the field. The PCL-130 sources and reads DC like a milliamp or voltage calibrator, simulates and measures T/Cs & RTDs like a temperature calibrator, generates and counts frequency and Counts-Per-Minute like a frequency calibrator and displays pressure like a precision test gauge. Troubleshooting? It checks continuity with a beeper and measures AC line voltage like a multimeter!

Calibrate Milliamp Inputs

Calibrate controllers, recorders and other devices in 4 to 20 or 0 to 20 mA loops. Source and read 0.00 to 24.00 mA, or Simulate a 2-Wire Transmitter. Use the optional AC adaptor for continuous operation. Display to 0.01 mA , 0.1 % of 4 to 20 and 0.1 % DP Flow.

Calibrate 2-Wire Transmitters

Easily calibrate 2-Wire Pressure and Electronic Transmitters by connecting the PCL-130 to both the input and output of the transmitter. The PCL-130 will simultaneously indicate the input and output of the transmitter on the graphical display.

Calibrate Pressure Systems

Read pressure with extreme accuracy using an external PM130 pressure module in a companion PCL130-MH module holder. Attach the module directly to the pressure connection for the best accuracy or with optional tubing for tight spots. Display to five digits within 0.025% of reading in up to 20 engineering units including psi, pa, Kpa, Mpa, BAR, mBar, Atm, Kgf plus torr, inches and mm of mercury

or water at a variety of temperatures. Each module is fully characterized for temperature and linearity to give you laboratory accuracy in the shop, control room or field.

Voltage Calibration

Calibrate all your DC millivolt and voltage instrumentation. Source from 0.00 to 110.00 mV and 0.00 to 10.25 V. Read up to 110.00 mV, 11.00 V and 200.0 VDC.

Temperature Calibration

Source and Read directly in °C and °F for T/C types J, K, T, E, R, S & N and four Pt 100 Ohm, Ni 120 Ohm and Cu 10 Ohm RTDs. Resolution to 0.1°. Cold junction compensation continuously tracks ambient temperature changes.

Frequency Calibration

Generate zero crossing square waves from 1 to 1000 Hz, 0.01 to 10.00 kHz and from 1 to 1000 CPM (Counts-Per-Minute). Built-in frequency counter measures Hz, kHz & CPM.

Measure AC Voltage

Check line voltage or mains from 0.0 to 250.0 volts AC. Great for troubleshooting power problems.

Check Continuity

Locate pairs of wires, open connections and shorts with the built-in beeper.

Rear Label - Condensed Operation Guide

①+ ②-	SOURCE mA, mV, V, Ω , 2-Wire RTD, Freq
③+ ④-	READ Ω , 2-Wire RTD, Freq & VDC to 10.25V
⑤+ ⑥-	SIMULATE 2-Wire Transmitters 
①+ ②-	READ Freq & VAC to 250V, VDC to 200V
③+ ④-	Power Measure 2-Wire Transmitter
⑤+ ⑥-	READ mA
①+ ②- ④-	SOURCE 3-Wire RTD
①+ ②- ③-	READ 3-Wire RTD
- □ □ +	SOURCE & READ T/C

 See manual for details.

GENERAL

TURN-ON

Each time you turn on the PCL-130 it runs through a self check then returns to the most recently selected settings.

SOURCE - The three QUIK-CHEK outputs will be the same as previously stored. Each time a different function is selected, the associated three QUIK-CHEK outputs will be recalled.

READ - The 130 is ready to measure the same signal as the last time it was used and automatically updates the MAX & MIN readings for recall at any time.

CONNECTIONS

PCL-130 has protected banana jacks compatible with standard and safety banana plugs.

Included with your TechChek are: a pair of safety test leads with test probes, safety alligator clips, standard alligator clips and spade lugs for attachment to a wide variety of instruments. An additional test lead and spade lug are also included for 3-Wire RTD connections.

A second pair of test leads with right angled safety banana plugs and alligator clips for mA Read and Power Transmitter functions. Thermocouple connections are made through a miniature thermocouple socket.

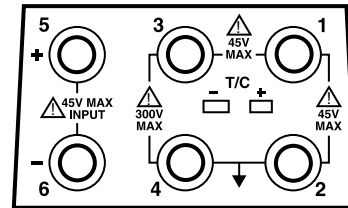

CAUTION! To prevent accidentally overloading the instrument being tested, correctly set up the outputs before connecting the PCL-130 to any instruments to be calibrated.

OPERATING INSTRUCTIONS

GENERAL

FIELD & BENCH USE

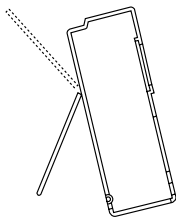

PCL-130 comes with a carrying case and a built-in tilt stand/hanger. The 130 is held securely in the case by VELCRO® for use with the carrying case open. The carrying case also has a snap-on belt loop which can be looped around a pipe or rail.

The tilt stand is easily raised by pulling the stand until it locks into place. The stand can also be reversed for use as a hanger to suspend the 130.

CHANGING BATTERIES

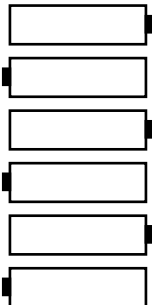

Low battery is indicated by a battery symbol on the display. Approximately four hours of operation remain before the LCD blanks and PCL-130 shuts itself down. Turn the 130 off, loosen the captive screw securing the battery compartment and lift off the cover from the bottom of the case. The six "AA" batteries are easily removed and replaced (alkaline supplied and recommended). Replace the battery compartment cover by inserting the tabs and tightening the screw.

OPERATING INSTRUCTIONS

GENERAL

CONFIGURING TEMPERATURE SCALES

The thermocouple and RTD ranges may be configured for full time use of °C, full time use of °F or selectable °C and °F operation. This configuration is part of the DEFAULT SETTINGS below.

AUTO-OFF

PCL-130 can be set up to turn itself off after 30 minutes of inactivity. The internal timer is reset to 30 minutes each time the digital pot is turned or a pushbutton is pressed.

DEFAULT SETTINGS

PCL-130 may be restored to the factory default setting. This will reset the HI and LO "QUIK-CHEK" memories according to the table below and the SET memory to midrange between HI and LO.

- 1) Press and hold the STORE/RESET push-button while turning the 130 on.
- 2) Keep pressing the push-button until SETTING UP DEFAULT appears on the display then release the push-button.
- 3) °F/°C SETUP appears on the display.
- 4) Turn the digital pot to select °F & °C, °F Only or °C Only. °C & °F is the default if no selection is made.
- 5) Press STORE/RESET push-button to store your choice or wait five seconds for the 130 to automatically store your choice and AUTO-OFF SETUP appears on the display.
- 6) Turn the digital pot to select AUTO-OFF ENABLE. AUTO-OFF causes the 130 to turn itself off after 30 minutes of inactivity to preserve the batteries. Select AUTO-OFF DISABLE for continuous operation.
- 7) Press STORE/RESET push-button to store your choice or wait five seconds for the 130 to automatically store your choice.
- 8) The firmware revision will be displayed, then the 130 will begin operation with the new settings.

QUIK-CHEK DEFAULTS

RANGE	LO	SET	HI
mA	4.00	12.00	20.00
mV	1.00	5.00	10.00
V	1.00	5.00	10.00
T/C J,T,E,K,N All points 0°C/32°F			
T/C R & S All points 538°C/1000°F			
Ohms	100.0	200.0	400.0
RTD	All points 0°C/32°F		
kHz	1.00	5.00	10.00
Hz	100	500	1000
CPM	100	500	1000

OPERATING INSTRUCTIONS

GENERAL

DISPLAY CONTRAST

The contrast of the Liquid Crystal Display may be adjusted for best readability.

- 1) Press and hold the DISPLAY/SOURCE/READ push-button while turning the 130 on to adjust the contrast of the display.
- 2) Turn the digital pot (knob) until the display is most legible.
- 3) Press the STORE/RESET push-button or wait five seconds for your selection to be stored.

DISPLAY BACKLIGHTING

The LCD may have too little contrast where the lighting is dim or the 130 is in shadow. Turn on the LCD backlighting to make the display easy to read.

- 1) If the PCL-130 is off, turn it on and wait for the display to come up in normal mode.
- 2) Press and hold the DISPLAY/SOURCE/READ push-button for three seconds and the backlight will turn on.

To extend the life of the batteries, it is recommended that the backlighting be turned off when the LCD is in normal light. Press and hold the DISPLAY/SOURCE/READ push-button for three seconds and the backlight will turn off.

TURN OFF

POWER

Press the POWER push-button to turn the 130 off. If AUTO-OFF is enabled, the 130 will turn itself off after 30 minutes of inactivity.

OPERATING INSTRUCTIONS

GENERAL

SELECTING FUNCTIONS

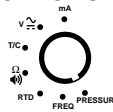

Turn the selector knob to choose among mA, V, T/C, Ω , RTD, FREQ and PRESSURE.

SELECTING RANGES

**TYPE
ENG UNITS**

Press the RANGE/TYPE pushbutton to select the desired range and scale.

SOURCE RANGES

Milliamp:

Source: mA, %mA (% 4-20), DP% (% Differential Pressure)

2-Wire Simulator: mA, %mA (% 4-20), DP% (% Differential Pressure)

VDC: mV, V

T/C: Types J, T, E, K, N, R & S in °C &°F

Ohms: Ohms

RTD: Four Pt 100 Ω , Ni 120 Ω & Cu 10 Ω in °C &°F

Frequency: KHz, Hz, CPM

READ RANGES

Milliamp: mA, %mA (% 4-20), DP% (% Differential Pressure)

VDC: mV, 10V, 200V

T/C: Types J, T, E, K, N, R & S in °C &°F

Ohms: Ohms

RTD: Four Pt 100 Ω , Ni 120 Ω & Cu 10 Ω in °C &°F

Frequency: KHz, Hz, CPM

AC Volts: VAC

TRANSMITTER RANGES

Pwr Xmtr: Supplies nominal 24 VDC to power the transmitter while measuring the transmitter milliamp signal. Can be simultaneously displayed with any Source Range or Pressure Measurement

Read mA: Measures transmitter output

OPERATING INSTRUCTIONS

SOURCE MODE

Select source by pressing the DISPLAY/SOURCE/READ pushbutton until the word SOURCE appears on the LCD display. To change the output value, turn the speed sensitive digital pot. Turning the knob slowly will cause a gradual change in the output. A faster rate of change will occur when the knob is turned faster. This function operates in all three output positions (HI, SET & LO).

STORING QUIK-CHEK OUTPUTS

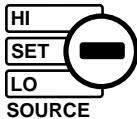

- 1) Switch to HI or LO
- 2) Turn the knob to desired value
- 3) Press the STORE push-button
The LCD will flash once to show that the value was saved

If a value is in the SET position and you want that value stored in HI or LO, press and hold the STORE push-button while moving the switch to HI or LO. The display will flash once to indicate the value has been stored. Then release the STORE push-button.

STORE
RESET

RECALLING QUIK-CHEK OUTPUTS

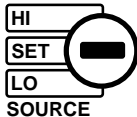

When you need a stored value just flip the QUIK-CHEK switch. Any value for the selected range may be stored in HI & LO. The PCL-130 remembers the HI, LO and SET values for each function with the power on or off. Each time a different function is selected, the last three QUIK-CHEK values for that function will be recalled.

OPERATING INSTRUCTIONS

CALIBRATE MILLIAMP INPUTS

mA, mA % (Percent of 4 to 20 mA), DP% (DP Flow)

Choose this function to provide an output from 0.00 to 24.00 milliamps. The compliance voltage is a nominal 24 VDC to provide the driving power to your milliamp receivers.

- 1) Disconnect one or both input wires from the device to be calibrated.
- 2) Turn the Selector Knob to mA
- 3) Press the DISPLAY/SOURCE/READ push-button until SOURCE or 2-WIRE appear on the display
- 4) If 2-WIRE is on the display, press the TYPE/ENG UNITS push-button once to indicate SOURCE on the display
- 5) Press the mA/%/DP FLOW push-button to display mA, % 4-20 or % DP Flow.
- 6) Connect the red SOURCE lead of the calibrator to the plus (+) input of the device and the black SOURCE lead to the minus (-).

Output current is continuously adjustable with the "QUIK-CHEK" switch in the SET position. Zero & Span (or any other values) are available by using the LO and HI "QUIK-CHEKs".

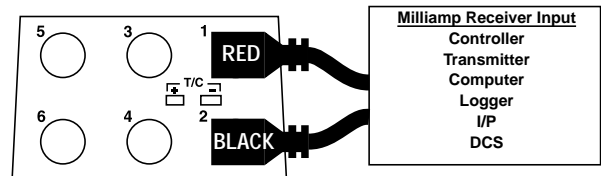

OPERATING INSTRUCTIONS

SIMULATE 2-WIRE TRANSMITTERS

2-WIRE mA, 2-WIRE % (Percent of 4 to 20 mA) 2-WIRE DP %
Choose this function to simulate a 2-Wire Transmitter output from 1.00 to 24.00 milliamps. Operates in loops with power supply voltages from 3 to 45 VDC.

- 1) Disconnect existing 2-Wire Transmitter from the loop
- 2) Turn the Selector Knob to mA
- 3) Press the DISPLAY/SOURCE/READ push-button until SOURCE or 2-WIRE appear on the display
- 4) If SOURCE is on the display, press the TYPE/ENG UNITS push-button once to indicate 2-WIRE on the display
- 5) Press the mA/%/% DP FLOW push-button to display mA, % 4-20 or % DP Flow.
- 6) Connect the red SOURCE lead of the calibrator to the plus (+) input of the device and the black SOURCE lead to the minus (-).

The simulated output of the 2-Wire Transmitter is continuously adjustable from 1.00 to 24.00 mA with the "QUIK-CHEK" switch in the SET position. Zero & Span (or any other values) are available by using the LO and HI "QUIK-CHEKs".

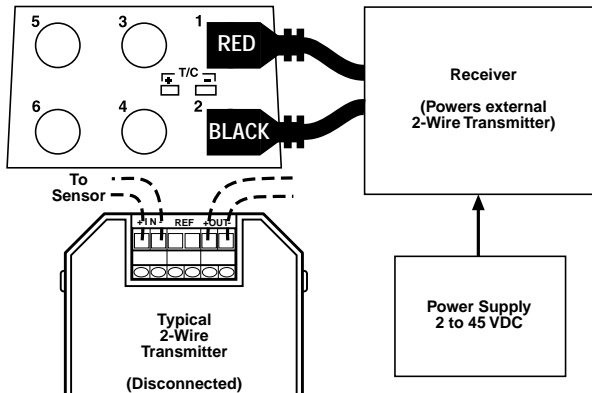

12

OPERATING INSTRUCTIONS

CALIBRATE VOLTAGE INPUTS

V, mV

Choose this function to provide an output from 0.00 mV to 110.00 mV and from 0.00 to 10.25 VDC. Current compliance up to 20 mA to provide the driving power to your voltage receivers.

- 1) Disconnect one or both input wires from the device to be calibrated
- 2) Turn the Selector Knob to V
- 3) Press the DISPLAY/SOURCE/READ push-button until SOURCE and V or mV appear on the display
- 4) Press the TYPE/ENG UNITS push-button once to switch between V and mV on the display
- 5) Connect the red SOURCE lead of the calibrator to the plus (+) input of the device and the black SOURCE lead to the minus (-).

Output voltage is continuously adjustable with the "QUIK-CHEK" switch in the SET position. Zero & Span (or any other values) are available by using the LO and HI "QUIK-CHEKs".

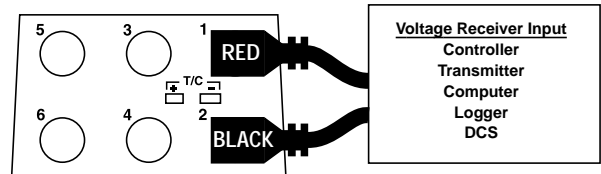

13

OPERATING INSTRUCTIONS

CHECK 1-5 VOLT INPUTS WITHOUT DISCONNECTING WIRES

Most 1-5 Volt receivers in 4-20mA loops have a 250 Ohm resistor across the input of the receiver. This resistor may be mounted internally or externally. PCL-130 is connected directly across the input of the 1-5 Volt receiver without disconnecting any field wiring. This saves a great deal of time when a large number of voltage receivers, such as chart recorders or computer systems, require calibration.

Make certain that changing the signal input will not disturb the process or cause unexpected alarms when checking on-line instruments. *It is important to remember the 130 drives only the device to which it is connected.* It has no effect on other devices in the 4 to 20 mA loop. PCL-130 will clamp the selected value in the mV and V Ranges to the maximum source or sink current of >16 mA.

- 1) Turn the Selector Knob to V
- 2) Press the DISPLAY/SOURCE/READ push-button until SOURCE and V or mV appear on the display
- 3) Press the TYPE/ENG UNITS push-button once to switch between V and mV on the display
- 4) Connect the red SOURCE lead of the calibrator to the plus (+) input of the device and the black SOURCE lead to the minus (-). Any associated 250 Ohm resistor must not be disconnected.

OPERATING INSTRUCTIONS

CHECK 1-5 VOLT INPUTS WITHOUT DISCONNECTING WIRES

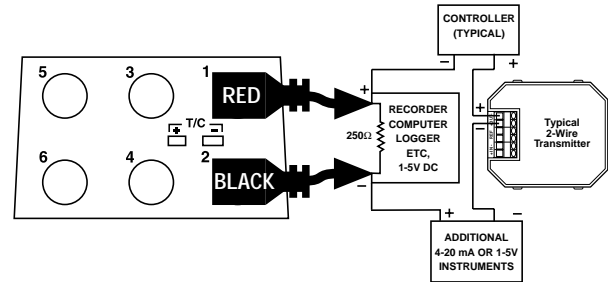

OPERATING INSTRUCTIONS

CALIBRATE THERMOCOUPLE INPUTS

Choose this function to simulate a thermocouple signal into any instrument requiring a thermocouple input. The output of the 130 is automatically cold junction compensated.

- 1) Disconnect the thermocouple from the instrument being calibrated.
- 2) Turn the Selector Knob to T/C
- 3) Press the DISPLAY/SOURCE/READ push-button until SOURCE and any T/C TYPE appear on the display
- 4) Use the proper thermocouple wire and corresponding miniature T/C connector to connect PCL-130 to the thermocouple.

Output temperature is continuously adjustable with the "QUIK-CHEK" switch in the SET position. Zero & Span (or any other values) are available by using the LO and HI "QUIK-CHEKs"

To Change the Thermocouple type

- 1) Press the TYPE/ENG UNITS push-button. The words SELECT T/C TYPE and the current selection appear on the display.
until the desired T/C type and temperature scale appear.
- 2) Turn the digital pot (knob) until the required type appears on the display.
- 3) Press the STORE/RESET push-button or wait 5 seconds to store the selection

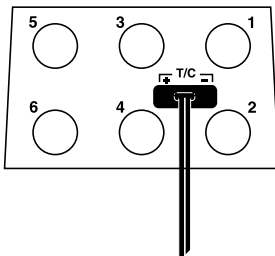
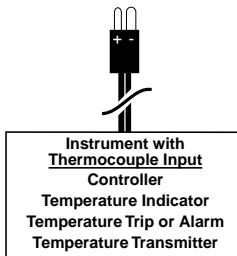

OPERATING INSTRUCTIONS

CALIBRATE RESISTANCE INPUTS

Choose this function to simulate a resistance into a variety of instruments.

- 1) Disconnect one or both input wires from the device to be calibrated
- 2) Turn the Selector Knob to Ω
- 3) Press the DISPLAY/SOURCE/READ push-button until SOURCE appears on the display
- 4) Connect the red SOURCE lead of the calibrator to the plus (+) input of the device and the black SOURCE lead to the minus (-).

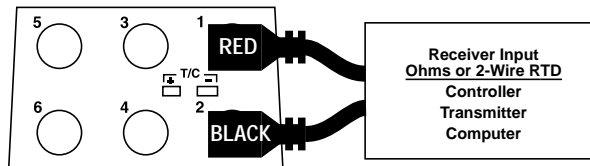

OPERATING INSTRUCTIONS

CALIBRATE RTD INPUTS

Choose this function to simulate a temperature signal into any instrument requiring an RTD input.

- 1) Disconnect the RTD from the instrument being calibrated.
- 2) Turn the Selector Knob to RTD
- 3) Press the DISPLAY/SOURCE/READ push-button until SOURCE and any RTD TYPE appear on the display
- 4) Connect using 2 or 3 wires as in the diagrams on the opposite page. Spade lugs are recommended to minimize any contact resistance.

Output temperature is continuously adjustable with the "QUIK-CHEK" switch in the SET position. Zero & Span (or any other values) are available by using the LO and HI "QUIK-CHEKS"

To Change the RTD type

- 1) Press the TYPE/ENG UNITS push-button. The words SELECT RTD TYPE and the current selection appear on the display.
- 2) Turn the digital pot (knob) until the required type appears on the display.
- 3) Press the STORE/RESET push-button or wait 5 seconds to store the selection

Note on 4-Wire Connections:

The PCL-130 may be used to calibrate instruments requiring a 4-Wire RTD connection. This connection is valid only when the lead wires included with the 130 are used to connect the 130 directly to the instrument. Use of longer wires can cause errors in the output setting.

For long 4-Wire cable runs use the 3-Wire connection and add a stacking banana jack (not available from Altek) to connect a second wire to jack #1. Connect this extra wire to the fourth wire field connection.

OPERATING INSTRUCTIONS

CALIBRATE RTD INPUTS

Two Wire RTD Connection

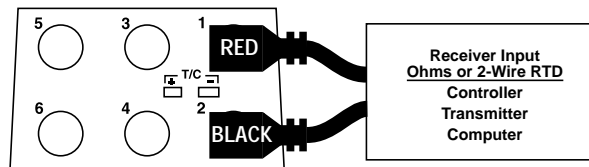

Three Wire RTD Connection

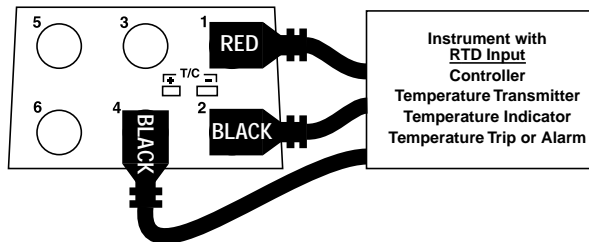

Four Wire RTD Connection

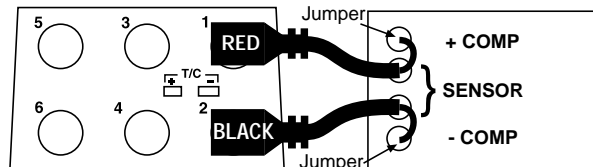

OPERATING INSTRUCTIONS

CALIBRATE FREQUENCY INPUTS

Choose this function to provide pulses into frequency measuring instruments. The 130 output is a zero crossing square wave from -1V to +5V amplitude. Available ranges are from 0.01 to 10.00 kHz, 1 to 1000 Hz and from 1 to 1000 CPM (Counts-Per-Minute). CPM is used to simulate extremely slow frequency signals with greater resolution. For example, 10 Hz is equivalent to 600 CPM. To convert from CPM to Hz Divide by 60. To convert from Hz to CPM multiply by 60.

- 1) Disconnect one or both input wires from the device to be calibrated
- 2) Turn the Selector Knob to **FREQ**
- 3) Press the **DISPLAY/SOURCE/READ** push-button until **SOURCE** and **KHz**, **Hz** or **CPM** appear on the display
- 4) Press the **TYPE/ENG UNITS** pushbutton to select between **KHz**, **Hz** or **CPM** on the display
- 5) Connect the red **SOURCE** lead of the calibrator to the plus (+) input of the device and the black **SOURCE** lead to the minus (-).

Output frequency is continuously adjustable with the "QUIK-CHEK" switch in the **SET** position. Zero & Span (or any other values) are available by using the **LO** and **HI** "QUIK-CHEKS"

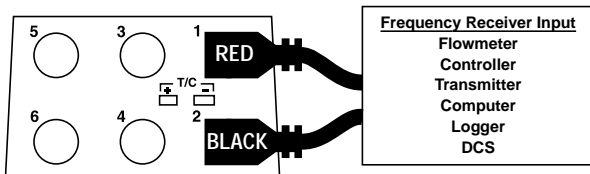

OPERATING INSTRUCTIONS

READ FUNCTIONS

Select read by pressing the **DISPLAY/SOURCE/READ** pushbutton until the word **READ** appears on the LCD display. The **READ** functions measure the desired signal. Multiple scales are available for some functions.

MIN/MAX



To read the Maximum or Minimum **INPUT** since **READ** mode was entered, simply switch to **MAX** or **MIN**. The value will appear on the LCD along with the word **MAX** or **MIN**. The **MAX/MIN** values are automatically updated and may be viewed at any time without interrupting the other values.

RESTARTING MIN/MAX



Pressing the **STORE/RESET** push-button will cause the 130 to store the present reading into the **MAX** and **MIN** memories. Upon releasing the **STORE/RESET** pushbutton the 130 will resume reading the input and update the **MAX** & **MIN** values as the measured signal changes.

OUT OF RANGE SIGNALS

OVER UNDER

Signals above or below those available for the currently selected range will be indicated by **OVER** and **UNDER** on the display.

OPERATING INSTRUCTIONS

READ MILLIAMP OUTPUTS

mA, mA % (Percent of 4 to 20 mA), DP% (DP Flow)

Choose this function to measure from 0.00 to +24.00 milliamps.

- 1) Open the current loop at any convenient point along the signal path
- 2) Turn the Selector Knob to mA
- 3) Press the DISPLAY/SOURCE/READ push-button until READ appears on the display
- 4) Press the mA/%/DP FLOW push-button to display mA, % 4-20 or % DP Flow.
- 5) Connect the red READ (+) lead of the calibrator to the more positive point of the break and the black READ lead (-) to the more negative

Display the present reading, Maximum or Minimum by moving the toggle switch from READ to MAX or MIN. If PCL-130 is connected in the wrong polarity, the word POL will flash on the display. Simply reverse the leads for correct indication.

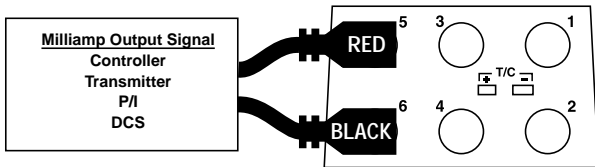

OPERATING INSTRUCTIONS

READ DC and AC VOLTAGE OUTPUTS

mV, V, Vhi and Vac

Choose this function to measure from 0.00 to 110.00 millivolts (mV), 0.00 to 10.25 DC Volts (V). Use the high voltage connection to read from 0.0 to 200.0 VDC (Vhi). See the next page for Volts AC.

- 1) Turn the Selector Knob to V
- 3) Press the DISPLAY/SOURCE/READ push-button until READ appears on the display
- 4) Press the TYPE/ENG UNITS push-button to select mV, V, Vhi or VAC on the display
- 5) Connect the red READ (+) lead and the black READ (-) lead of the calibrator across the voltage to be measured.

Signals above or below those available for the currently selected range will be indicated by OVER and UNDER on the display.

Connection for millivolts(mV) and Volts below 10.25 VDC (V)

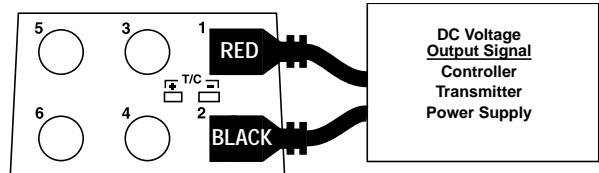

Connection for DC Volts to 200.0 (vhi)

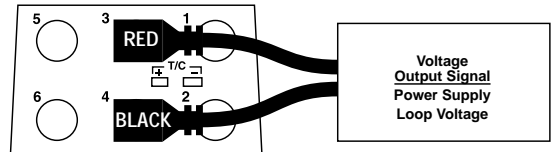

OPERATING INSTRUCTIONS

READ AC VOLTAGES

Choose this function to measure from 0.0 to 250.0 V True RMS.

- 1) Turn the Selector Knob to V
- 3) Press the DISPLAY/SOURCE/READ push-button until READ appears on the display
- 4) Press the TYPE/ENG UNITS pushbutton to select VAC on the display
- 5) Connect the red READ (+) lead and the black READ (-) lead of the calibrator across the voltage to be measured.

Signals above or below those available for the currently selected range will be indicated by OVER and UNDER on the display.

CAUTION: Care should be used when measuring AC voltage. The included safety test probes or safety alligator clips should be used. Do not exceed voltage limits shown on calibrator.

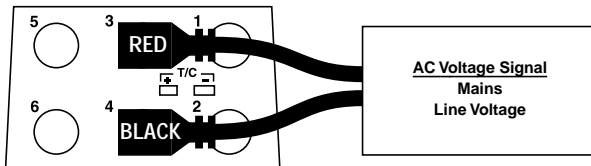

OPERATING INSTRUCTIONS

MEASURE THERMOCOUPLE SENSORS

Choose this function to read a thermocouple. The input of the PCL-130 is automatically cold junction compensated.

- 1) Disconnect the thermocouple from any instrument.
- 2) Turn the Selector Knob to T/C
- 3) Press the DISPLAY/SOURCE/READ push-button until READ and any T/C TYPE appear on the display
- 4) Use the proper thermocouple wire and corresponding miniature T/C connector to connect PCL-130 to the thermocouple.

To Change the Thermocouple type

- 1) Press the TYPE/ENG UNITS push-button. The words SELECT T/C TYPE and the current selection appear on the display.
- 2) Turn the digital pot (knob) until the required type appears on the display.
- 3) Press the STORE/RESET push-button or wait 5 seconds to store the selection

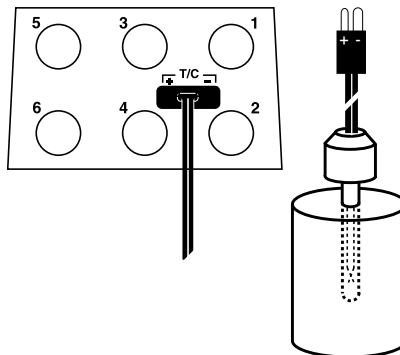

OPERATING INSTRUCTIONS

READ RESISTANCE

Ohms

Choose this function to measure resistance from 0.0 to 1000.0 Ohms.

- 1) Disconnect one or both input wires from the device to be calibrated
- 2) Turn the Selector Knob to Ω
- 3) Press the DISPLAY/SOURCE/READ push-button until READ or CONTINUITY appears on the display
- 4) Press the TYPE/ENG UNITS push-button once to switch between READ and CONTINUITY on the display
- 5) Connect the red READ (+) lead and the black READ (-) lead of the calibrator across the resistance to be measured.

Signals above or below those available for the currently selected range will be indicated by OVER and UNDER on the display.

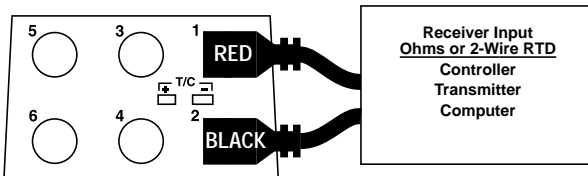

OPERATING INSTRUCTIONS

CHECK CONTINUITY

Choose this function to check continuity. A tone will sound and a sound symbol will appear on the display when the resistance between the leads is less than 100 Ohms.

- 1) Plug the leads into the PCL-130 as shown below.
- 2) Turn the Selector Knob to Ω
- 3) Press the DISPLAY/SOURCE/READ push-button until READ or CONTINUITY appears on the display
- 4) Press the TYPE/ENG UNITS pushbutton once to switch between READ and CONTINUITY on the display

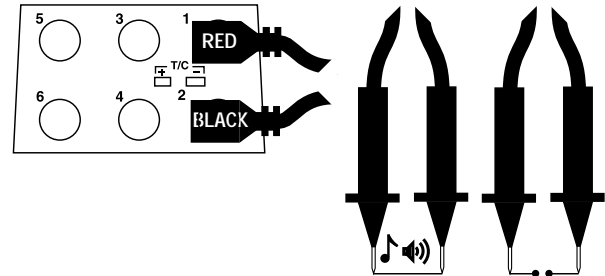

OPERATING INSTRUCTIONS

MEASURE RTD SENSORS

Choose this function to read an RTD. Three wires must be use for both 2 and 3 wire RTDs.

- 1) Disconnect the RTD from the instrument being calibrated.
- 2) Turn the Selector Knob to RTD
- 3) Press the DISPLAY/SOURCE/READ push-button until SOURCE and any RTD TYPE appear on the display
- 4) Connect using 3 wires as in the diagrams on the opposite page. Use a 3 wire connection to read a 4 wire RTD (all four wires must be the same gauge). Spade lugs are recommended to minimize any contact resistance.

Output temperature is continuously adjustable with the "QUIK-CHEK" switch in the SET position. Zero & Span (or any other values) are available by using the LO and HI "QUIK-CHEKS"

To Change the RTD type

- 1) Press the TYPE/ENG UNITS push-button. The words SELECT RTD TYPE and the current selection appear on the display.
- 2) Turn the digital pot (knob) until the required type appears on the display.
- 3) Press the STORE/RESET push-button or wait 5 seconds to store the selection

OPERATING INSTRUCTIONS

MEASURE RTD SENSORS

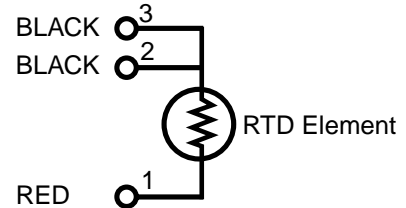
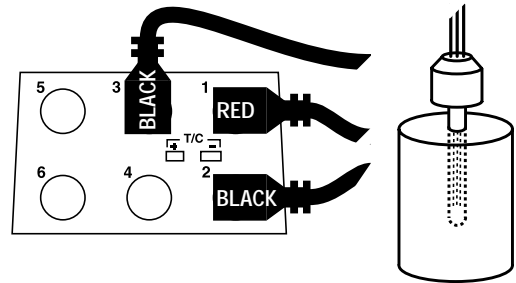

OPERATING INSTRUCTIONS

COUNT FREQUENCIES

Choose this function to use the 130 as a frequency counter. Available ranges are from 0.01 to 10.00 kHz, 1 to 1000 Hz and from 1 to 1000 CPM (Counts-Per-Minute).

To measure waveforms with amplitudes between 1 V and 10.25 V RMS use the low level inputs. Use the high voltage connection to read waveforms with amplitudes from 10.25 to 250.0 V RMS

- 1) Disconnect one or both input wires from the device to be calibrated
- 2) Turn the Selector Knob to **FREQ**
- 3) Press the **DISPLAY/SOURCE/READ** push-button until **READ** and **KHz**, **Hz** or **CPM** appear on the display
- 4) Press the **TYPE/ENG UNITS** push-button to select between **KHz**, **Hz** or **CPM** on the display
- 5) Connect the red **READ** lead of the calibrator to the plus (+) input of the device and the black **READ** lead to the minus (-)

OPERATING INSTRUCTIONS

COUNT FREQUENCIES

Connection for signals with amplitudes below 10.25V RMS

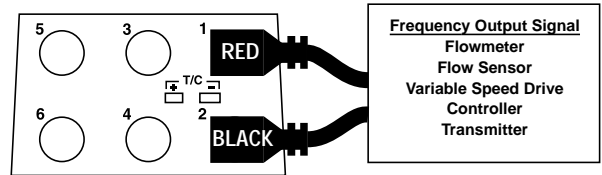

Connection for signals with amplitudes to 250 V RMS

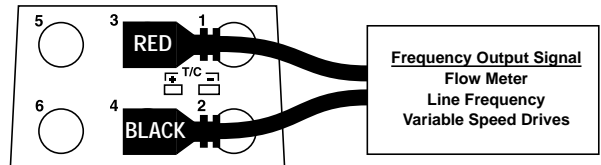

OPERATING INSTRUCTIONS

CALIBRATE TRANSMITTERS

ANY SOURCE FUNCTION AND READ mA, READ %, READ DP%

Choose this function to supply the input signal to the transmitter and displaying the 4-20 mA output of the transmitter (used with 4-Wire Transmitters).

ANY SOURCE FUNCTION AND P-XMTR mA, P-XMTR %, P-XMTR DP%

Choose this function to simultaneously supply power to a 2-Wire transmitter while supply the input signal to the transmitter and display the 4-20 mA output of the transmitter.

- 1) Disconnect both the input and output wires from the 2-Wire Transmitter to be calibrated
- 2) Turn the selector knob to set the output of the 130 to match the input of the transmitter (T/C, RTD, Freq, etc.). Select the proper type, range and temperature scale if applicable.
- 3) Press the DISPLAY/SOURCE/READ push-button until READ or P-XMTR appears in the lower half of the display
- 4) Press READ/POWER TRANSMITTER to switch between reading milliamps and supply voltage to power the transmitter
- 5) Connect the output of the 130 to the signal input of the transmitter (using the 1,2 & 4 connectors or the T/C connector on the 130)
- 6) Connect the red POWER lead of the 130 (Connector 5) to the plus (+) output of the transmitter and the black POWER lead (Connector 6) to the minus (-)

The output is continuously adjustable with the "QUIK-CHEK" switch in the SET position. Zero & Span (or any other values) are available by using the LO and HI "QUIK-CHEKs".

The PCL-130 supplies a nominal 24 Volts DC at 24 mA to the 2-Wire transmitter. The current output of the transmitter will be accurately displayed by the 130. Calibrate the Transmitter in the usual manner and disconnect the 130.

OPERATING INSTRUCTIONS

CALIBRATE 2-WIRE TRANSMITTERS

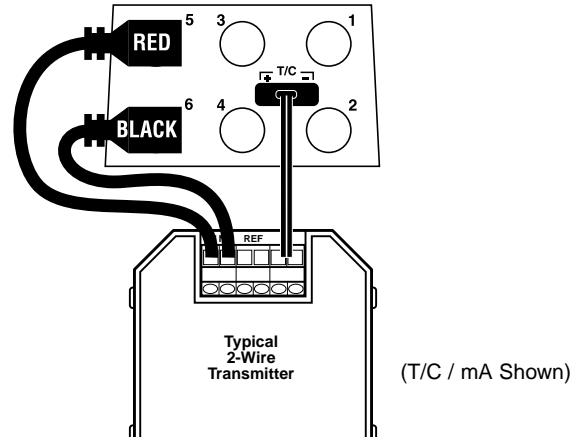

CALIBRATE 4-WIRE TRANSMITTERS

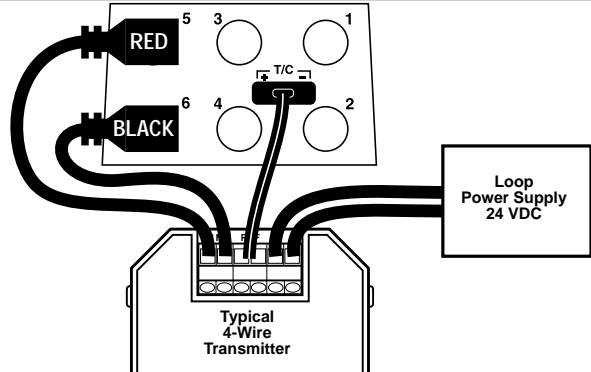

OPERATING INSTRUCTIONS

READ PRESSURE

WARNING! - SAFETY CONSIDERATIONS

Sudden release of compressed or stored gas can cause personal injury. Always vent the system before making pressure connections or disconnections. Exercise standard physical protection practices such as eye protection, gloves, protective clothing, etc.

To prevent the potentially hazardous release into the atmosphere of substances introduced into the pneumatic system by the user, no relief valves are provided in the PM130 Pressure Module. Consequently, if a module is overpressurized, the sensor will be damaged.

FITTING INSTALLATION

All pneumatic connections to the PM130 Module are made via 1/8"-27 NPT threads in the pressure port. Adapter fittings may be used for 1/4"-18, straight 10-32 threads or any other size fittings to match the field connections.

To install a fitting in a module pressure port:

- 1) Apply Teflon tape or pipe dope to the fitting threads (Teflon tape not recommended with stainless steel fittings)
- 2) Carefully install the fitting in the pressure port on top of the module
- 3) Use a 5/8" wrench to support the pressure module port and a second wrench to tighten the fitting
- 4) Check for leaks

OPERATING INSTRUCTIONS

READ PRESSURE

Choose this function to measure pressure with a PCL130-MH module holder and one of the many PM130 pressure modules.

- 1) Select the proper module for the pressure range of the process
- 2) Place the PM130 Module in the PCL130-MH holder
- 3) Plug the ModPak cable into the mating connector on the 130
- 4) Turn the selector knob to PRESSURE
- 5) The 130 will display - - - - - for up to 20 seconds while the module is powered up and verified
- 6) The 130 will display the range of the module for three seconds
- 7) Press the °C/°F/ZERO push-button to "Zero" the pressure reading

Carefully connect the module to the pressure point to be measured.

To Change the pressure engineering units

- 1) Press the TYPE/ENG UNITS push-button. The words SELECT ENG. UNITS and the current selection appear on the display.
- 2) Turn the digital pot (knob) until the required type appears on the display.
- 3) Press the STORE/RESET push-button or wait 5 seconds to store the selection

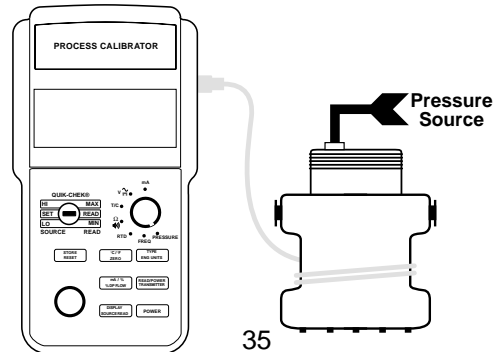

OPERATING INSTRUCTIONS

CALIBRATE PRESSURE TRANSMITTERS

READ PRESSURE AND

P-XMTR mA, P-XMTR %, P-XMTR DP%

Choose this function to simultaneously supply power to a 2-Wire pressure transmitter while supplying the input signal to the transmitter and displaying the 4-20 mA output of the transmitter.

- 1) Disconnect both the pressure input and output wires from the 2-Wire Transmitter to be calibrated
- 2) Select the proper module for the pressure range of the process
- 3) Place the PM130 Module in the PCL130-MH holder
- 4) Plug the ModPak cable into the mating connector on the 130
- 5) Turn the selector knob to PRESSURE
- 6) The 130 will display ----- for up to 20 seconds while the module is powered up and verified
- 7) The 130 will display the range of the module for three seconds
- 8) Press the °C/°F/ZERO push-button to "Zero" the pressure reading
- 9) Press the DISPLAY/SOURCE/READ push-button until READ or P-XMTR appears in the lower half of the display
- 10) Press READ/POWER TRANSMITTER to switch between reading milliamps and supply voltage to power the transmitter
- 11) *Carefully* make all pressure connections
- 6) Connect the red POWER lead of the 130 (Connector 5) to the plus (+) output of the transmitter and the black POWER lead (Connector 6) to the minus (-)

Use the hand pump or regulated pressure source to adjust the pressure

The PCL-130 supplies a nominal 24 Volts DC at 24 mA to the 2-Wire transmitter. The current output of the transmitter will be accurately displayed by the 130. Calibrate the Transmitter in the usual manner and disconnect the 130.

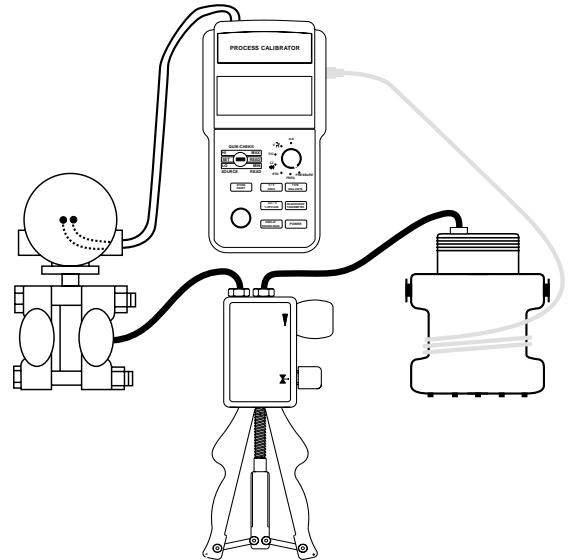

OPERATING INSTRUCTIONS

CALIBRATE I/P (CURRENT TO PRESSURE) TRANSDUCERS

READ PRESSURE AND

mA, mA % (Percent of 4 to 20 mA), DP% (DP Flow) OR

2-WIRE mA, 2-WIRE % (Percent of 4 to 20 mA) 2-WIRE DP %

Choose this function to simultaneously supply the 4-20 mA control signal to an I/P transducer while displaying the pressure output of the transducer.

- 1) Shut off or disconnect the input pressure and disconnect both the pressure output and input wires from the I/P to be calibrated
- 2) Select the module for the pressure range of the process
- 3) Place the PM130 Module in the PCL130-MH holder
- 4) Plug the ModPak cable into the mating connector on the 130
- 5) Turn the selector knob to mA and press TYPE to select mA (using the internal supply) or 2-WIRE (to use an external power supply)
- 6) Turn the selector knob to PRESSURE
- 7) The 130 will display - - - - - for up to 20 seconds while the module is powered up and verified
- 8) The 130 will display the range of the module for three seconds
- 9) Press the °C/°F/ZERO push-button to "Zero" the pressure reading
- 10) Press the DISPLAY/SOURCE/READ push-button until SOURCE or 2-WIRE appear in the upper half of the display
- 11) *Carefully* make all pressure connections
- 12) Connect the red POWER lead of the 130 (Connector 1) to the plus (+) output of the transmitter and the black POWER lead (Connector 2) to the minus (-)

Turn on or re connect a constant supply of pressure to the pressure input of the I/P.

The output is continuously adjustable with the "QUIK-CHEK" switch in the SET position. Zero & Span (or any other values) are available by using the LO and HI "QUIK-CHEKs".

The pressure output of the I/P will be accurately displayed by the 130. Calibrate the I/P in the usual manner and disconnect the 130.

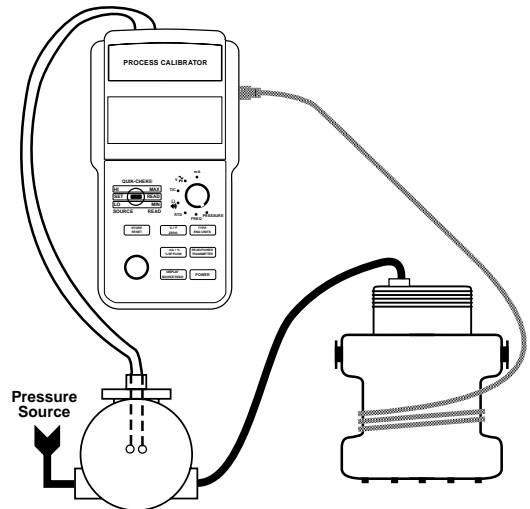

SPECIFICATIONS

GENERAL

TYPICAL 90 DAY ACCURACY: $\pm(0.025\%$ of Full Scale + 1 LSD)¹

1 YEAR ACCURACY: $\pm(0.05\%$ of Full Scale + 1 LSD)

WARM UP TIME: 10 seconds to specified accuracy, 2 minutes to maximum accuracy

TEMPERATURE EFFECT: $\pm 0.01\%$ per °C based on 23°±25°C

BATTERIES: Six "AA", (R6) batteries (Alkaline supplied and recommended)

BATTERY LIFE:

MILLIAMP SOURCE & 2-WIRE MODES: Nominal 12 hours at 20 mA with 250Ω load; OTHER FUNCTIONS: Nominal 30 hours

Note: Battery life is reduced when LCD backlighting is on

LOW BATTERY INDICATION: "BAT" indication on the display at approximately 4 hours left

OVERLOAD PROTECTION: Two fuses - LITTLEFUSE R451.125

NOISE: ± 1 LSD at frequencies less than 10 Hz

NORMAL MODE REJECTION RATIO: 50 dB @ 50/60 Hz

OPERATING TEMPERATURE RANGE: -5 to +130 °F (-20 to +55°C)

STORAGE TEMPERATURE RANGE: -13 to +130°F (-25 to +55°C)

RELATIVE HUMIDITY: 10 to 90%, non-condensing for 24 hours from 0 to 35°C

OVERALL SIZE: 158.1 x 83.1 x 49.3 mm (6.23 x 3.27 x 1.94")

WEIGHT: 0.6 kg (1 lb, 5 oz)

MILLIAMP SOURCE

RANGES:

0.00 to 24.00 mA; -25.0 to 125.0 % of 4 to 20 mA; % DP Flow

ACCURACY: $\pm(0.05\%$ of 24 mA Span + 0.01 mA) = 0.02mA

TYPICAL DRIVE CAPABILITY: 1200 Ohms @ 20.00 mA

COMPLIANCE VOLTAGE: nominal 25 V @ 20 mA

¹Typical 90 day accuracy can be estimated by dividing the 1 year % of full scale accuracy by 2. Additions to the specification, such as + 1 LSD, remain constant

Specifications subject to change without notice

SPECIFICATIONS

POWER & MEASURE 2-WIRE TRANSMITTERS

RANGES & ACCURACY: Same as for MILLIAMP SOURCE

OUTPUT CURRENT: up to 24.00 mA

TYPICAL DRIVE CAPABILITY: 1200 Ohms @ 20.00 mA

COMPLIANCE VOLTAGE: nominal 25 VDC @ 20 mA

COMMON MODE ERROR: 0.01% Full Scale/Common Mode Volt

2-WIRE TRANSMITTER SIMULATOR

RANGES:

1.00 to 24.00 mA; -18.8 to 125.0% of 4 to 20 mA; % DP Flow

ACCURACY: Same as for MILLIAMP SOURCE

LOOP VOLTAGE LIMITS: Minimum, 3 VDC; Maximum 45 VDC

OVERLOAD PROTECTION: Current limited to 25 mA nominal

COMMON MODE ERROR: 0.01% Full Scale/Common Mode Volt

MILLIAMP READ

RANGES:

0.00 to 24.00 mA; -25.0 to 125.0 % of 4 to 20 mA; % DP Flow

ACCURACY: Same as for MILLIAMP SOURCE

OVERLOAD PROTECTION: Current limited to 25 mA nominal

VOLTAGE BURDEN: 0.9V at 4 mA, 1.2V at 20 mA, 1.9V at 24 mA

DC VOLTAGE SOURCE

RANGES: 0.00 to 110.00 mV; 0.00 to 10.25V

ACCURACY:

$\pm(0.05\%$ of 110 mV+ 0.01mV) = ± 0.07 mV

$\pm(0.05\%$ of 10.25 V + 0.01V) = ± 0.02 V

SOURCE CURRENT: >20 mA

SINK CURRENT: >20 mA

OUTPUT IMPEDANCE: <0.3 Ohms

SHORT CIRCUIT DURATION: Infinite

MEASURE AC VOLTS

RANGE: 0.0 to 250.0 V True RMS

ACCURACY: From 10 to 250 VAC $\pm(2\%$ of 250 V + 0.1 VAC) = ± 5.1 VAC

MAXIMUM CREST FACTOR: < 3

FREQUENCY RANGE: 45 to 800 Hz

SPECIFICATIONS

MEASURE DC VOLTS

RANGES:

0.00 to 110.00 mV; 0.00 to 10.25 V; 0.0 to 200.0 V

ACCURACY:

$\pm(0.05\% \text{ of } 110 \text{ mV} + 0.01\text{mV}) = \pm 0.07 \text{ mV}$

$\pm(0.05\% \text{ of } 10.25 \text{ V} + 0.01\text{V}) = \pm 0.02\text{V}$

$\pm(2\% \text{ of } 200.0 \text{ V} + 0.1\text{V}) = \pm 4.1 \text{ V}$

INPUT RESISTANCE: >1 Meg Ohm to 10.25V, >5 Meg Ohm to 200V

SOURCE RESISTANCE EFFECT: 0.01% per 100 Ohms

SOURCE THERMOCOUPLES

THERMOCOUPLE TYPES: J, K, T, E, N, R & S

RESOLUTION: 1°C or 1°F

ACCURACY: °C $\pm(0.05\% \text{ OF } 80 \text{ MV} + 1^\circ\text{C})$; °F $\pm(0.05\% \text{ OF } 80 \text{ MV} + 1^\circ\text{F})$

COLD JUNCTION ACCURACY: $\pm 1^\circ\text{C}$

COLD JUNCTION EFFECT: within 0.05°C per °C change

OUTPUT IMPEDANCE: <0.3 Ohms

SOURCE CURRENT: >10 mA, Max

READ THERMOCOUPLES

THERMOCOUPLE TYPES & ACCURACY: Same as for SOURCE T/C

RESOLUTION: 0.1°C or 0.1°F

COLD JUNCTION ACCURACY: $\pm 1^\circ\text{C}$

COLD JUNCTION EFFECT: within 0.05°C per °C change

INPUT IMPEDANCE: > 1 Meg Ohm

OPEN THERMOCOUPLE DETECTION: 450 millisecond pulse.

Nominal threshold, 10 K Ohms.

READ OHMS

RANGE OHMS: 0.0 to 1000.0 Ohms

ACCURACY: $\pm(0.05\% \text{ of } 1000.0 \text{ Ohms} + 0.1 \text{ Ohm}) = \pm 0.6 \text{ Ohms}$

EXCITATION CURRENT SUPPLIED: 1 mA, nominal

CONTINUITY CHECKING

TEST CURRENT: Nominal 1 mA

THRESHOLD: 100 Ohm $\pm 20\%$

INDICATION: Steady tone & Symbol on LCD plus Ohm Reading

SPECIFICATIONS

SOURCE RTD & OHMS

RTD TYPES:

Pt 100 Ω for 1.3850 (DIN/IEC 751 & New JIS), 1.3902 (Burns), 1.3926 (US Lab) & 1.3916 (Old JIS 1604C-1981)

Ni 120 Ω and Cu 10 Ω

RTD RESOLUTION: 1°C or 1°F

RANGE OHMS: 0.0 to 400.0 Ohms

ACCURACY: $\pm 0.05\%$ of Full Scale + 0.075 mV/mA Excitation Current

ACCURACY OHMS: $\pm(0.05\% \text{ of } 400.0 \text{ Ohms} + 0.1 \text{ Ohm}) = \pm 0.3 \text{ Ohms}$
(At 1 mA Excitation Current)

TEMPERATURE EFFECT: $\pm((0.035 \text{ mV}/^\circ\text{C}) * (1/\text{mA Excitation Current}))$

ALLOWABLE EXCITATION CURRENT: 0.125 to 2.0 mA continuous DC

READ RTD

RTD TYPES & RESOLUTION: Same as for SOURCE RTD

RTD RANGE (IN OHMS): 0.0 to 400.0 Ohms

RTD ACCURACY (OHMS): $\pm(0.05\% \text{ of } 400.0 \text{ Ohms} + 0.1 \text{ Ohm}) = \pm 0.3 \text{ Ohms}$

EXCITATION CURRENT SUPPLIED: 1 mA, nominal

FREQUENCY SOURCE

RANGES: 1 to 1000 CPM (Count-Per-Minute); 1 to 1000 Hz, 0.01 to 10.00 kHz

ACCURACY:

$\pm(0.05\% \text{ of } 1000 \text{ CPM} + 1 \text{ CPM}) = \pm 2 \text{ CPM}$

$\pm(0.05\% \text{ of } 1000 \text{ Hz} + 1 \text{ Hz}) = \pm 2 \text{ Hz}$

$\pm(0.05\% \text{ of } 10.00 \text{ kHz} + 0.01 \text{ kHz}) = \pm 0.02 \text{ kHz}$

OUTPUT WAVEFORM: Square Wave, Zero Crossing, -1V to +5V $\pm 10\%$

RISETIME: Hz <5 microseconds; CPM <100 microseconds

OUTPUT IMPEDANCE: <100 Ohms

SOURCE CURRENT: >1 mA at 10 kHz

SHORT CIRCUIT DURATION: Infinite

MEASURE FREQUENCY

RANGES & ACCURACY: Same as for FREQUENCY SOURCE

TRIGGER LEVEL: 1 V RMS, DC coupled to 10.25 V;

7 V RMS, DC coupled to 250 V

INPUT IMPEDANCE: > 1Meg Ohm + 60 pF

THERMOCOUPLE SPECIFICATIONS

T/C TYPE	°C		°F	
	RANGE	ACCURACY	RANGE	ACCURACY
J	100 to 1200	±1.7	212 to 2192	±2.3
	-50 to 99	±1.8	-58 to 211	±2.5
	-150 to -49	±2.2	-238 to -57	±3.2
	-200 to -149	±2.8	-328 to -237	±4.3
K	1100 to 1372	±2.2	2012 to 2500	±3.1
	0 to 1099	±2.0	32 to 2011	±2.9
	-100 to -1	±2.3	-148 to 31	±3.3
	-200 to -99	±3.6	-328 to -147	±5.7
T	200 to 400	±1.7	392 to 752	±2.4
	0 to 199	±1.9	32 to 391	±2.7
	-100 to -1	±2.4	-148 to 31	±3.5
	-200 to -99	±3.5	-328 to -147	±5.6
E	250 to 1000	±1.5	482 to 1832	±2.0
	50 to 249	±1.6	122 to 481	±2.1
	-100 to 49	±1.9	-148 to 121	±2.6
	-200 to -99	±2.6	-328 to -147	±3.9

THERMOCOUPLE SPECIFICATIONS

T/C TYPE	°C		°F	
	RANGE	ACCURACY	RANGE	ACCURACY
N	300 to 1300	±2.1	572 to 2372	±3.0
	100 to 299	±2.3	212 to 571	±3.3
	-50 to 99	±2.6	-58 to 211	±4.0
	-200 to -49	±5.0	-328 to -57	±8.2
R	1750 to 1768	±4.2	3182 to 3214	±6.9
	950 to 1749	±4.0	1742 to 3181	±6.5
	650 to 949	±4.4	1202 to 1741	±7.2
	300 to 649	±5.1	572 to 1201	±8.4
S	1700 to 1768	±4.9	3092 to 3214	±8.0
	1050 to 1699	±4.4	1922 to 3091	±7.1
	700 to 1049	±4.8	1292 to 1921	±7.8
	300 to 699	±5.4	572 to 1291	±8.9

Note: Thermocouple accuracies are based on an 80.00 mV Span
 T/C Accuracy for °C is $\pm(0.05\% \text{ of } 80.00 \text{ mV} + 1^\circ\text{C})$
 T/C Accuracy for °F is $\pm(0.05\% \text{ of } 80.00 \text{ mV} + 1^\circ\text{F})$

Source resolution is 1 °C or °F. Read resolution is 0.1 °C or °F

RTD SPECIFICATIONS

RTD TYPE	ALPHA	°C RANGE	ACCURACY
Pt 100Ω (DIN/IEC/JIS 1989)	1.3850	-100 to 850	±1
Pt 100Ω (Burns)	1.3902	-100 to 648	±1
Pt 100Ω (Old JIS 1981)	1.3916	-100 to 648	±1
Pt 100Ω (US Lab)	1.3926	-100 to 862	±1
Ni 120Ω	1.6720	-80 to 273	±1
Cu 10Ω	1.4274	-200 to 260	±8

RTD TYPE	ALPHA	°F RANGE	ACCURACY
Pt 100Ω (DIN/IEC/JIS 1989)	1.3850	-148 to 1562	±2
Pt 100Ω (Burns)	1.3902	-148 to 1200	±2
Pt 100Ω (Old JIS 1981)	1.3916	-148 to 1200	±2
Pt 100Ω (US Lab)	1.3926	-148 to 1584	±2
Ni 120Ω	1.6720	-112 to 524	±2
Cu 10Ω	1.4274	-328 to 500	±1

RTD resolution is 1 °C or °F.

PM130 MODULE SPECIFICATIONS

OPERATING TEMPERATURE: -10°C TO 50°C (13°F TO 122°F)
STORAGE TEMPERATURE: -40°C TO 85°C (-40°F TO 185°F)
WEIGHT: 0.4 kg (14.5 oz)
TEMPERATURE EFFECT: None (Compensated over full range)
CONNECTION: 1/8" NPT FEMALE
MEDIA COMPATIBILITY: Any liquid or gas compatible with 316 stainless steel and fluorocarbon rubber

Modules

PM130-5	0 to 5 psi
PM130-10	0 to 10 psi
PM130-30	0 to 30 psi
PM130-100	0 to 100 psi
PM130-300	0 to 300 psi
PM130-500	0 to 500 psi
PM130-1000	0 to 1000 psi
PM130-2500	0 to 2500 psi

Module Accuracy

PM130-5 ±(0.025% of rdg +0.0005 psi)
 PM130-10 ±(0.025% of rdg +0.001 psi)
 PM130-30 ±(0.025% of rdg +0.003 psi)
 PM130-100 ±(0.025% of rdg +0.009 psi)
 PM130-300 ±(0.025% of rdg +0.027 psi)
 PM130-500 ±(0.025% of rdg +0.035 psi)
 PM130-1000 ±(0.025% of rdg +0.01 psi)
 PM130-2500 ±(0.025% of rdg +0.25 psi)

Additional modules are frequently being added to the PM130 line

OMEGA ENGINEERING, INC. warrants this unit to be free of defects in materials and workmanship for a period of 37 months from date of purchase. OMEGA Warranty adds an additional one (1) month grace period to the normal three (3) years product warranty to cover handling and shipping time. This ensures that OMEGA's customers receive maximum coverage on each product.

If the unit should malfunction, it must be returned to the factory for evaluation. OMEGA's Customer Service Department will issue an Authorized Return (AR) number immediately upon phone or written request. Upon examination by OMEGA, if the unit is found to be defective it will be repaired or replaced at no charge. OMEGA's WARRANTY does not apply to defects resulting from any action of the purchaser, including but not limited to mishandling, improper interfacing, operation outside of design limits, improper repair, or unauthorized modification. This WARRANTY is VOID if the unit shows evidence of having been tampered with or shows evidence of being damaged as a result of excessive corrosion; or current, heat, moisture or vibration; improper specification; misapplication; misuse or other operating conditions outside of OMEGA's control. Components which wear are not warrantable, including but not limited to contact points, fuses, and triacs.

OMEGA is pleased to offer suggestions on the use of its various products. However, OMEGA neither assumes responsibility for any omissions or errors nor assumes liability for any damages that result from the use of its products in accordance with information provided by OMEGA, either verbal or written. OMEGA warrants only that the parts manufactured by it will be as specified and free of defects.

OMEGA MAKES NO OTHER WARRANTIES OR REPRESENTATIONS OF ANY KIND WHATSOEVER, EXPRESSED OR IMPLIED, EXCEPT THAT OF TITLE, AND ALL IMPLIED WARRANTIES INCLUDING ANY WARRANTY OF MERCHANTABILITY AND FITNESS FOR A PARTICULAR PURPOSE ARE HEREBY DISCLAIMED.

LIMITATION OF LIABILITY: The remedies of purchaser set forth herein are exclusive and the total liability of OMEGA with respect to this order, whether based on contract, warranty, negligence, indemnification, strict liability or otherwise, shall not exceed the purchase price of the component upon which liability is based. In no event shall OMEGA be liable for consequential, incidental or special damages.

CONDITIONS: Equipment sold by OMEGA is not intended to be used, nor shall it be used: (1) as a "Basic Component" under 10 CFR 21 (NRC), used in or with any nuclear installation or activity; or (2) in medical applications or used on humans. Should any Product(s) be used in or with any nuclear installation or activity, medical application, used on humans, or misused in any way, OMEGA assumes no responsibility as set forth in our basic WARRANTY/DISCLAIMER language, and additionally, purchaser will indemnify OMEGA and hold OMEGA harmless from any liability or damage whatsoever arising out of the use of the Product(s) in such a manner.



OMEGAnetSM On-Line Service http://www.omega.com	Internet e-mail info@omega.com
---	--

Servicing North America:

USA: ISO 9001 Certified
One Omega Drive, Box 4047
Stamford, CT 06907-0047
Tel: (203) 359-1660 FAX: (203) 359-7700
e-mail: info@omega.com

Canada: 976 Bergar
Laval (Quebec) H7L 5A1
Tel: (514) 856-6928 FAX: (514) 856-6886
e-mail: canada@omega.com

For immediate technical or application assistance:

USA and Canada:
Sales Service: 1-800-826-6342 / 1-800-TC-OMEGASM
Customer Service: 1-800-622-2378 / 1-800-622-BESTSM
Engineering Service: 1-800-872-9436 / 1-800-USA-WHENSM
TELEX: 996404 EASYLINK: 62968934 CABLE: OMEGA

Mexico and Latin America:
Tel: (95) 800-TC-OMEGASM FAX: (95) 203-359-7807
En Espanol: (203) 359-1660 ext: 2203
e-mail: espanol@omega.com

Servicing Europe:

Benelux:

Postbus 8034, 1180 LA Amstelveen, The Netherlands
Tel: (31) 20 6418405 FAX: (31) 20 6434643
Toll Free in Benelux: 06 0993344
e-mail: nl@omega.com

Czech Republic:

Ostravska 767, 733 01 Karvina
Tel: 420 (69) 6311627 FAX: 420 (69) 6311114
e-mail: czech@omega.com

France:

9, rue Denis Papin, 78190 Trappes
Tel: (33) 130-621-400 FAX: (33) 130-699-120
Toll Free in France: 0800-4-06342
e-mail: france@omega.com

Germany/Austria:

Daimlerstrasse 26, D-75392 Deckenpfronn, Germany
Tel: 49 (07056) 3017 FAX: 49 (07056) 8540
Toll Free in Germany: 0130 11 21 66
e-mail: germany@omega.com

United Kingdom: ISO 9002 Certified

25 Swannington Road, P.O. Box 7, Omega Drive,
Broughton Astley, Leicestershire, Irlam, Manchester,
LE9 6TU, England M44 5EX, England
Tel: 44 (1455) 285520 Tel: 44 (161) 777-6611
FAX: 44 (1455) 283912 FAX: 44 (161) 777-6622
Toll Free in England: 0800-488-488
e-mail: uk@omega.com

It is the policy of OMEGA to comply with all worldwide safety and EMC/EMI regulations that apply. OMEGA is constantly pursuing certification of its products to the European New Approach Directives. OMEGA will add the CE mark to every appropriate device upon certification.

The information contained in this document is believed to be correct but OMEGA Engineering, Inc. accepts no liability for any errors it contains, and reserves the right to alter specifications without notice.

WARNING: These products are not designed for use in, and should not be used for, patient connected applications.

Where Do I Find Everything I Need for Process Measurement and Control? OMEGA...Of Course!

TEMPERATURE

- ☑ Thermocouple, RTD & Thermistor Probes, Connectors, Panels & Assemblies
- ☑ Wire: Thermocouple, RTD & Thermistor
- ☑ Calibrators & Ice Point References
- ☑ Recorders, Controllers & Process Monitors
- ☑ Infrared Pyrometers

PRESSURE, STRAIN AND FORCE

- ☑ Transducers & Strain Gauges
- ☑ Load Cells & Pressure Gauges
- ☑ Displacement Transducers
- ☑ Instrumentation & Accessories

FLOW/LEVEL

- ☑ Rotameters, Gas Mass Flowmeters & Flow Computers
- ☑ Air Velocity Indicators
- ☑ Turbine/Paddlewheel Systems
- ☑ Totalizers & Batch Controllers

pH/CONDUCTIVITY

- ☑ pH Electrodes, Testers & Accessories
- ☑ Benchtop/Laboratory Meters
- ☑ Controllers, Calibrators, Simulators & Pumps
- ☑ Industrial pH & Conductivity Equipment

DATA ACQUISITION

- ☑ Data Acquisition & Engineering Software
- ☑ Communications-Based Acquisition Systems
- ☑ Plug-in Cards for Apple, IBM & Compatibles
- ☑ Datalogging Systems
- ☑ Recorders, Printers & Plotters

HEATERS

- ☑ Heating Cable
- ☑ Cartridge & Strip Heaters
- ☑ Immersion & Band Heaters
- ☑ Flexible Heaters
- ☑ Laboratory Heaters

ENVIRONMENTAL MONITORING AND CONTROL

- ☑ Metering & Control Instrumentation
- ☑ Refractometers
- ☑ Pumps & Tubing
- ☑ Air, Soil & Water Monitors
- ☑ Industrial Water & Wastewater Treatment
- ☑ pH, Conductivity & Dissolved Oxygen Instruments