



MDPC Series Pressure Controller

Instruction Sheet

Thank you very much for choosing MDPC series pressure controller. Please read this instruction sheet carefully before using your MDPC. Keep this instruction sheet handy for quick reference.

1 Warning

- ⚠ DANGER! CAUTION! ELECTRIC SHOCK!**
- ⚠ MDPC is a pressure measurement device. DO NOT use it out of its specification. Improper pressure or incorrect wiring may cause serious injuries to staff or damages on other devices.**
- Keep away from high-voltage and high-frequency environments during installation to avoid interference. Avoid using the device in areas which contain:
 - dust or corrosive gas;
 - high humidity and high radiation;
 - shock and vibration.
 - MDPC can only be used for air pressure measurement and should avoid use of corrosive, inflammable or toxic gas.
 - Power supply should be switched off during installation or when dismantling MDPC and that pressure source has been deactivated to avoid bodily harm and property damage.
 - DO use parts compatible to the specification of the pressure connection to avoid false readings or safety issues.
 - Before switching the power supply on, check that the signal connection has the proper input voltage and polarity. Voltage that is too high may cause damage to the MDPC.
 - DO use dry cloth and DO NOT use acid or alkaline liquid to clean the device.

2 Product Profile & Outline

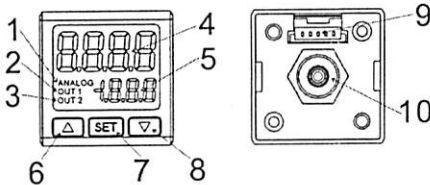

1. Analog output indicator	6. UP key
2. Digital output 1 indicator	7. SET key
3. Digital output 2 indicator	8. DOWN key
4. PV/parameter display	9. Power supply and output terminals
5. SV/setup item display	10. Pressure input connection

- Contents in the pack: Pressure controller, signal wire, unit sticker, instruction sheet
- Optional accessories: Panel mounting parts, bracket mounting parts

3 Ordering Information

MDPC- [1] [2] [3]

Series name	MDPC: Mini Digital Pressure Controller
[1] Measurable pressure range	1: -14.5psi to 14.5psi (-100kPa to 100kPa) 2: -14.5psi to 145psi (-100kPa to 1,000kPa)
[2] Output types	1: NPN output, 4 to 20mA; 3: PNP output, 4 to 20mA 2: NPN output, 1 to 5V; 4: PNP output, 1 to 5V
[3] Pressure connections types	1: Outer connection PT1/8", inner connection M5; 2: Outer connection NPT1/8", inner connection M5

4 Specifications

Power supply	Voltage range	12 to 24V DC +/- 10% no isolation
	Power consumption	40 mA max.; current output type 60 mA max.
Pressure measurement	Pressure type	Non-corrosive gas, gauge type
	Measurable range	MDPC-1: -14.5psi to 14.5psi (-100kPa to 100kPa)
		MDPC-2: -14.5psi to 145psi (-100kPa to 1,000kPa)
	Max. durable pressure	MDPC-1: 29psi (200kPa)
		MDPC-2: 217psi (1,500kPa)
	Accuracy	+/- 3% entire process
Temperature inaccuracy	+/- 2% entire process	
Display	Setup display	2-line LCD display, 4 digits for measured value and 3.5 digits for setup display
	Status display	LCD output status display
	Display mode	3 colors for different modes: red, green, orange
	Cycle update	100ms, 250ms, 500ms, 1,000ms programmable

Output	Switch type	2 NPN or PNP transistor digital outputs and 1 analog output
	Transistor output	NPN: Max. durable pressure 30V/100mA, residual voltage 1.5V
		PNP: Max. durable pressure 30V/100mA, residual voltage 1.5V
	Analog output	1 to 5V: Min. output load resistance 1,000Ω
		4 to 20mA: Max. output load resistance 400Ω; linear inaccuracy < 2% entire process
Response time	2ms, 4ms, 10ms, 30ms, 50ms, 100ms, 250ms, 500ms, 1,000ms, 5,000ms programmable	
Output inaccuracy	Linear inaccuracy: < +/- 2% entire process	
Connection	P	Outer connections PT 1/8", inner connections M5
	N	Outer connections NPT 1/8", inner connections M5
Shock resistance		10 to 500Hz, 10mm 3 axes for 2 hours
Vibration resistance		Max. 100m/s ² 3 axes 6 directions, 3 times each
Ambient temperature		0°C to 50°C
Storage temperature		-20°C to 65°C
Altitude		< 2,000m
Ambient humidity		35% to 80% RH (non-condensing)

5

How to Set up Parameters

- Switching modes:** MDPC will be in the "Measuring Mode" when it is switched on, displaying pressure value (PV) and set value (SV). Press **SET** for more than 2 seconds in this mode to switch to the "Quick Setup Mode". Press **SET** for more than 4 seconds in the "measuring mode" to switch to "Advanced Setup Mode". Press **SET** in the "Quick Setup Mode" or "Advanced Setup Mode" to return to the "Measuring Mode".
- Setting up parameters:** In the three modes, press **SET** once to select the parameter to set up. When the correct parameter chosen to be modified has been selected, use **▲** **▼** to modify the setting.

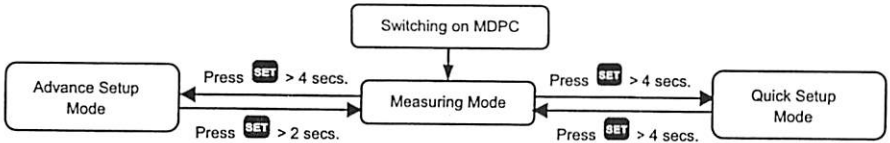

Quick Setup Mode:

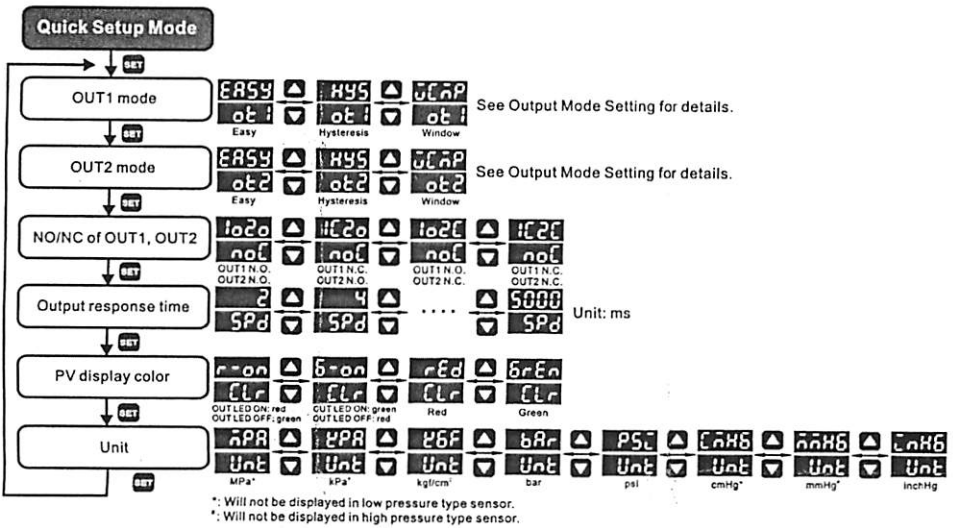

Advanced Setup Mode:

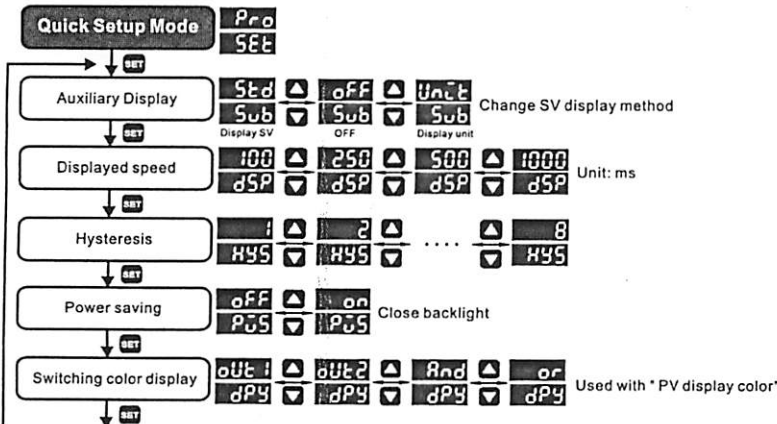

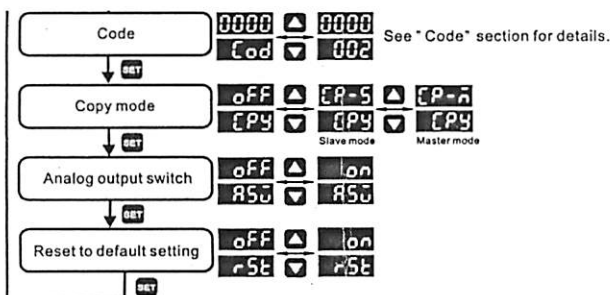

• Measuring Mode:

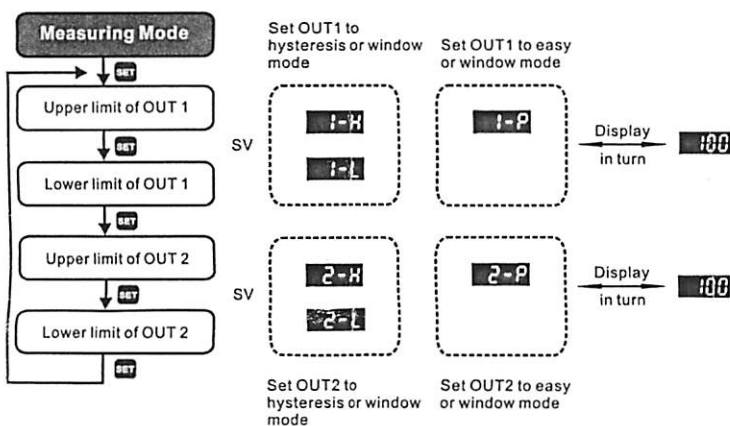

Quick Setup Mode	Advanced Setup Mode	Measuring Mode
o1i Set up OUT1 mode Press SET ▾	Sub Set up auxiliary display (Change SV display method) Press SET ▾	I-H Set up upper limit of OUT1 (Set OUT1 to hysteresis mode / window mode) Press SET ▾
o2i Set up OUT2 mode Press SET ▾	dSp Set up displayed speed Press SET ▾	I-L Set up lower limit of OUT1 (Set OUT1 to hysteresis mode / window mode) Press SET ▾
noC Set up N.O./N.C. of OUT1 and OUT2 Press SET ▾	HYS Set up hysteresis Press SET ▾	I-P SV of OUT1 (Set OUT1 to easy mode) Press SET ▾
SPd Set up output response time Press SET ▾	POs Set up power saving mode Press SET ▾	2-H Set up upper limit of OUT2 (Set OUT2 to hysteresis mode / window mode) Press SET ▾
CLr Set up PV display color Press SET ▾	dPY Set up switching color referencing output items Press SET ▾	2-L Set up lower limit of OUT2 (Set OUT2 to hysteresis mode / window mode) Press SET ▾
UnE Set up unit Press SET ▾ Return to "set up OUT1 mode"	CoD Set up code Press SET ▾	2-P SV of OUT2 (Set OUT2 to easy mode) Press SET ▾ Returning to output setting
	CPY Set up copy function Press SET ▾	
	AS0 Set up analog output switch Press SET ▾	
	rSt Return to default settings Press SET ▾ Return to "set up auxiliary display"	

Units: MDPC has many available units, including kPa, kgf/cm², bar, psi, mmHg and inchHg. In the easy mode,

- Press **SET** to find **UnE** to set to the desired unit.
- Output status: There are 2 output statuses available in MDPC, N.O. (normally open) and N.C. (normally closed). In the easy mode, press **SET** to find **noC** and set up the output status for OUT1 and OUT2.

3. Response time: This refers to the time required for the pressure to reach output status. In the easy mode, press **SET** and find **SPd**. For example, "50" refers to once the pressure has reached the output status, it has to last for 50/ms before the output starts to operate. Use **▲** **▼** to set up the response time.

7 Output Mode Setting

There are 3 output modes in MDPC: Easy, Hysteresis and Window

1. Easy Mode: This is for setting up pressure P. When the pressure measured is larger than $(P + dP)$, the output will be ON. When the pressure measured is smaller than P, the output will be OFF. (See Figure 1: Output in Easy Mode)
 - In the "Measuring Mode", press **SET** and find **1-P** (OUT1) and **2-P** (OUT2). Use **▲** **▼** to set up P value.
 - In the "Advanced Setup Mode", press **SET** and find **HYS**. Use **▲** **▼** to set up "dP" value.
2. Hysteresis Mode: This is for setting up pressure Hi/Lo. When the pressure measured is larger than the Hi value, the output will be ON. When the pressure measured is smaller than the Lo value, the output will be OFF. (See Figure 2: Output in Hysteresis Mode)
 - In the "Measuring Mode", press **SET** and find **1-H** (OUT1 Hi), **1-L** (OUT1 Lo), **2-H** (OUT2 Hi) and **2-L** (OUT2 Lo). Use **▲** **▼** to set up Hi/Lo values.

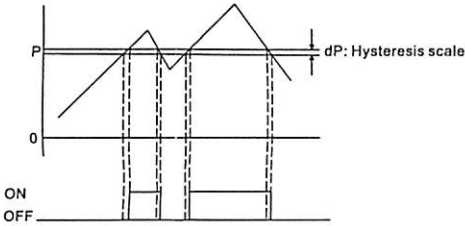

[Figure 1: Output in Easy Mode]

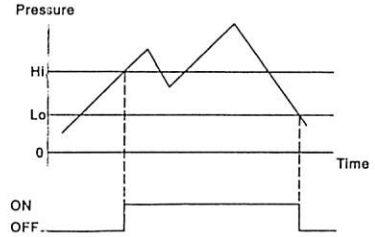

[Figure 2: Output in Hysteresis Mode]

3. Window Mode: This is for setting up pressure Hi/Lo. When the pressure measured is larger than Hi or smaller than Lo, the output will be OFF. When the pressure measured is larger than Lo and smaller than Hi, the output will be ON. (See Figure 3: Output in Window Mode)
 - In the "Measuring Mode", press **SET** and find **1-H** (OUT1 Hi), **1-L** (OUT1 Lo), **2-H** (OUT2 Hi) and **2-L** (OUT2 Lo). Use **▲** **▼** to set up Hi/Lo values.
 - In the "Advanced Setup Mode", press **SET** and find **HYS**. Use **▲** **▼** to set up "dP" value.

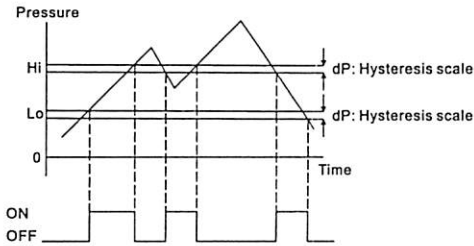

[Figure 3: Output in Window Mode]

Note: If the output is ON and the output status is set to N.O. (normally open), the output will then be off. If the output status is set to N.C. (normally closed), the output will then be on. If the output is OFF and the output status is set to N.O., the output will then be on. If the output status is set to N.C., the output will then be off.

8 Zero Returning

In the "Measuring Mode", press **▲** **▼** together, and you will see **0000**. The zero returning will start. Release the keys to end the zero return.

9 Analog Output

When the input pressure starts to change, the analog output will change with the input. For example, suppose the range for input is -14.5psi to 14.5psi (-100kPa to 100kPa), and MDPC reads -14.5psi (-100kPa), the output will be 4mA or 1V. When MDPC reads 14.5psi (100kPa), the output will be 20mA or 5V. (See Figure 4: Analog Output)

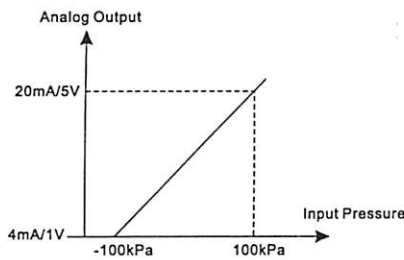

[Figure 4: Analog Output]

10 Key Locking Function

- Lock On: Press **SET** and **▲** together for 2 seconds until **LoCk on** is displayed. You will then see the display of

pressure value (PV) and set value (SV).

- Lock Off: Press **SET** and **☑** together for 2 seconds until **LoOff** is displayed. You will then see the display of pressure value (PV) and set value (SV).
- Lock Display: Press any key in the key locking mode, and you will see the display of pressure value (PV) and **LoCD** (SV). Release the key, and the pressure value (PV) and set value (SV) will return to original values.

11

Switching Colors

In MDPC, different output statuses can have different display colors. The output statuses for MDPC are "OUT1", "OUT2", "OUT1 and OUT2", "OUT1 or OUT2". See below explanations for how to set:

1. Setting up output status: In the "Measuring Mode", press **SET** for more than 4 seconds and release the key after you see **Pro**. You are now in the "Advanced Setup Mode". Press **SET** 5 times and find the switching color referencing items (see Advanced Setup Mode chart). Use **▲** **▼** to select the referencing item you'd like.
2. Switching colors: In the "Measuring Mode", press **SET** for more than 2 seconds to enter the "Quick Setup Mode". Press **SET** 5 times and find the parameter for setting up colors (see Quick Setup Mode chart). Use **▲** **▼** to select the color you'd like.

Note: "OUT1 and OUT2" will be ON only when both OUT1 and OUT2 are ON; otherwise, it will be OFF. "OUT1 or OUT2" will be OFF only when both OUT1 and OUT2 are OFF; otherwise, it will be ON.

12

Copy Function

MDPC is able to copy the parameters in the master device to another slave device.

1. Hardware: Connect Pin 2 on master to Pin 3 on slave; Pin 3 on master to Pin 2 on slave; Pin 5 on master and slave to GND on power supply; Pin 1 on master and slave to +24 on power supply.
2. Software:

- a) Slave device: In the "Measuring Mode", press **SET** for more than 4 seconds and release the key after you see **Pro**. You are now in the "Advanced Setup Mode". Press **SET** 7 times and find the parameter for setting up the copy function (see Advanced Setup Mode chart). Use **▲** **▼** to select **CP-S** (**CP-S** refers to Copy-Slave).
- b) Master device: In the "Measuring Mode", press **SET** for more than 2 seconds and release the key after you see **Pro**. You are now in the "Advanced Setup Mode". Press **SET** 7 times and find the parameter for setting up the copy function (see Advanced Setup Mode chart). Use **▲** **▼** to select **CP-M** (**CP-M** refers to Copy-Master). Next, press **SET** for more than 2 seconds and return to the "Measuring Mode". Now, you will see **CP-M** on the screen and **CP-S** on the slave device, indicating that the two devices have been connected. On **LoE**, you will see numbers counting up, referring to the number of parameters transmitted successfully between the two devices. Once the copy of parameters is successful, you will see **CP-M** on the master device and **CP-S** on the slave device. If the number at **LoE** remains the same, it is an indication that the copy of parameters was not successful.

After the copy is completed, switch off the two devices and connect them again to the power supply.

13

Code

MDPC offers easy programming codes for the user to set up. In the "Measuring Mode", press **SET** for more than 4 seconds and release the key after you see **Pro**. You are now in the "Advanced Setup Mode". Press **SET** 6 times to find the parameter the user would like to set up codes for (see Advanced Setup Mode chart). **0000** ← **0000** displays in turn.

See the meanings of codes in the table below:

Code	1 st digit		2 nd digit		3 rd digit	Color	Referencing item for color
	OUT1 mode	N.O./N.C.	OUT2 mode	N.O./N.C.			
0	Easy	N.O.	Easy	N.O.	2ms	Red when ON	OUT1
1		N.C.		N.C.	4ms		OUT2
2	Hysteresis	N.O.	Hysteresis	N.O.	10ms		OUT1 and OUT2
3		N.C.		N.C.	30ms		OUT1 or OUT2
4	Window	N.O.	Window	N.O.	50ms	Green when ON	OUT1
5		N.C.		N.C.	100ms		OUT2
6	-	-	-	-	250ms		OUT1 and OUT2
7	-	-	-	-	500ms		OUT1 or OUT2
8	-	-	-	-	1,000ms	Red	OUT1
9	-	-	-	-	-		OUT2
R	-	-	-	-	-		OUT1 and OUT2
b	-	-	-	-	-	Red	OUT1 or OUT2
c	-	-	-	-	-	Green	OUT1
d	-	-	-	-	-		OUT2

Code	1 st digit		2 nd digit		3 rd digit	Color	Referencing item for color
	OUT1 mode	N.O./N.C.	OUT2 mode	N.O./N.C.	Response time		
F	-	-	-	-	-		OUT1 and OUT2
F	-	-	-	-	-		OUT1 or OUT2

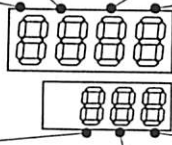

Code	6 th digit	7 th digit	8 th digit
	Pressure unit	Speed	Hysteresis setting
0	kPa	250ms	Standard
1	kgf/cm ²		Off
2	bar		Unit
3	psi	500ms	Standard
4	mmHg		Off
5	inchHg		Unit
6	-	1,000ms	Standard
7	-		Off
8	-		Unit
9	-	-	-

14 How to Install

• Panel

• Bracket: A-152

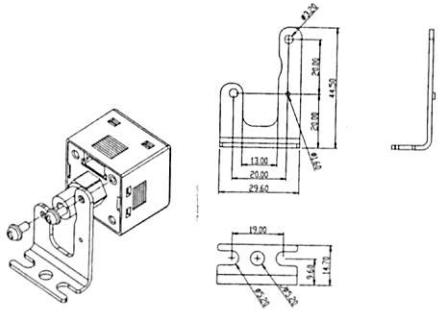
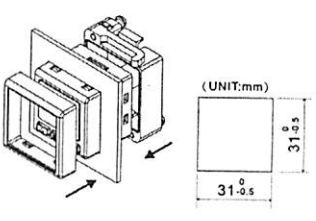

• To install the panel mounting, you have to purchase the optional accessory: A-153

15 Dimension

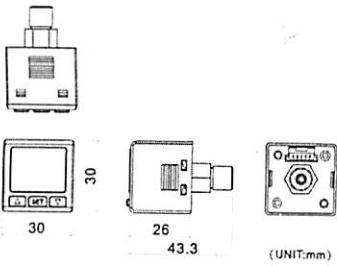

16 Terminals

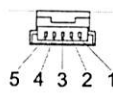

1. Positive power supply (brown)
2. Digital output 1 signal (black)
3. Digital output 2 signal (white)
4. Analog output signal (orange)
5. Negative power supply (blue)

17 Internal Circuit

